

INOXCROM[®] B2B

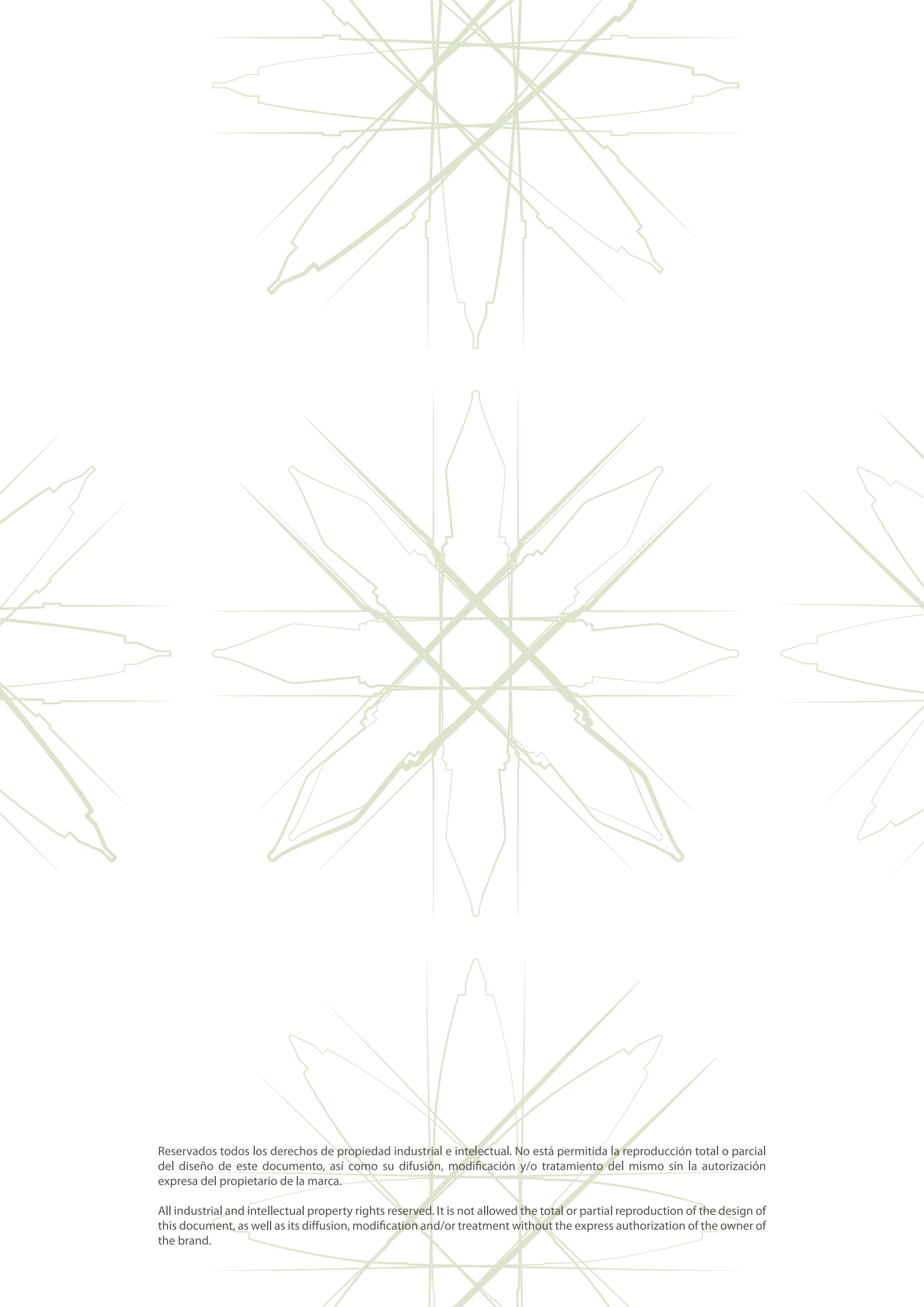

Reservados todos los derechos de propiedad industrial e intelectual. No está permitida la reproducción total o parcial del diseño de este documento, así como su difusión, modificación y/o tratamiento del mismo sin la autorización expresa del propietario de la marca.

All industrial and intellectual property rights reserved. It is not allowed the total or partial reproduction of the design of this document, as well as its diffusion, modification and/or treatment without the express authorization of the owner of the brand.

atracción impacción conexión

Cada vez los productos se parecen más entre sí y es más difícil para los consumidores distinguir sus atributos.

La imagen de marca es un aval que garantiza la calidad del producto situándolo en un plano superior, construyendo una verdadera identidad y relación emocional con los consumidores.

El regalo corporativo ha sido una herramienta utilizada desde hace mucho tiempo como obsequio a clientes, empleados, proveedores o colaboradores en general, como detalle de cortesía con ocasión de un acontecimiento determinado o simplemente como recuerdo y promoción de una marca.

Aún tratándose de un obsequio, no debemos olvidar que el consumidor inevitablemente asociará la calidad de éste con la calidad de su marca. Y es aquí donde nuestros productos pretenden potenciar al máximo esta percepción, ofreciendo la máxima calidad, fundamentalmente en la escritura y proponiéndole un diseño personalizado del mensaje que desea transmitir.

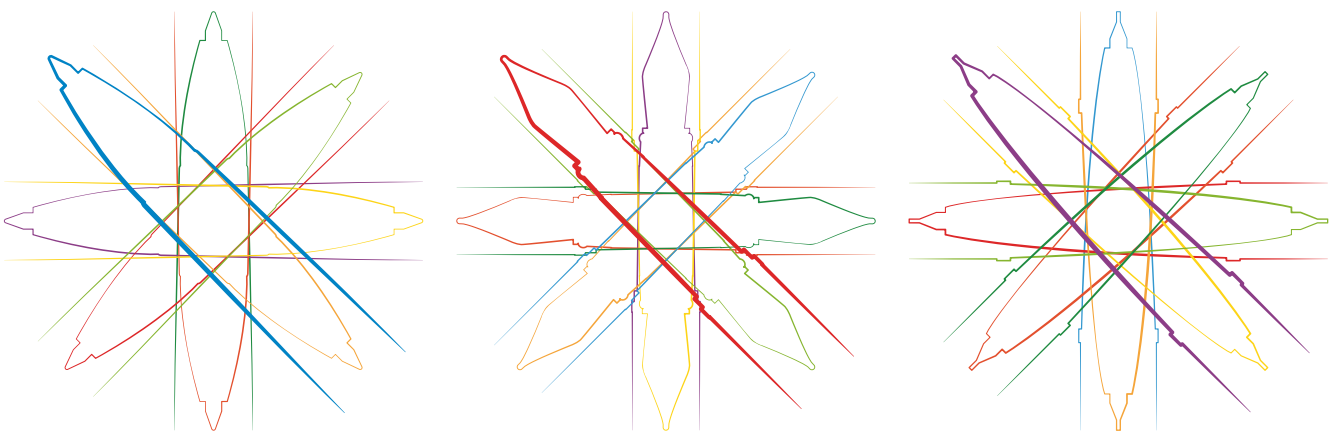



Rocker
Speed
Venture
Canvas

INOXCROM[®]
Promocional



Bolígrafo

Rocker

Mecanismo de pulsación.

Cuerpo ABS. Terminales plástico translúcido

Recambio de bolígrafo INOXCROM®, 5.200 m. de escritura, trazo de 1mm.

Peso: 10,5 gr.

Longitud: 128 mm.

Ø: 10 mm

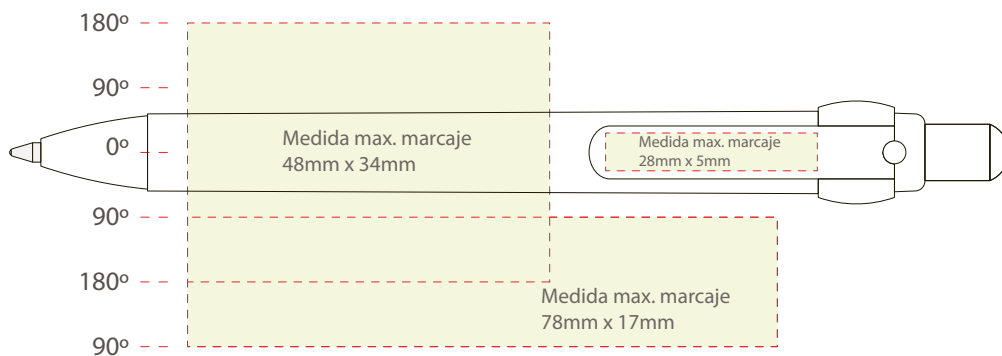



Tinta libre (roller)

Speed

Cuerpo y capuchón ABS/Polipropileno
 Clip metálico cromado
 Tinta libre tipo roller. Color AZUL. Trazo 0,7mm
 Peso: 12,5 gr.
 Longitud: 135mm
 ø: 11mm

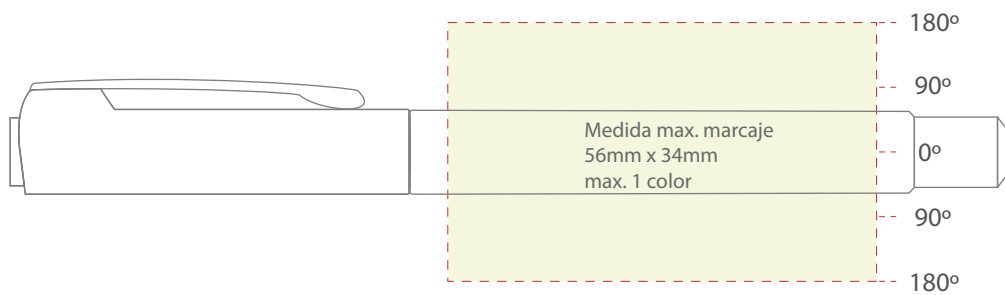



ALUMINIUM



Bolígrafo

Venture



Mecanismo de pulsación. Cuerpo de aluminio pintado mate.
 Puntera/pulsador plástico pintado mate. Clip metálico cromado mate.
 Recambio de bolígrafo INOXCROM® con punta de acero inoxidable y bola de carburo de tungsteno de 1mm.
 Peso: 18 gr.
 Longitud: 139 mm.
 Ø: 9,85 mm

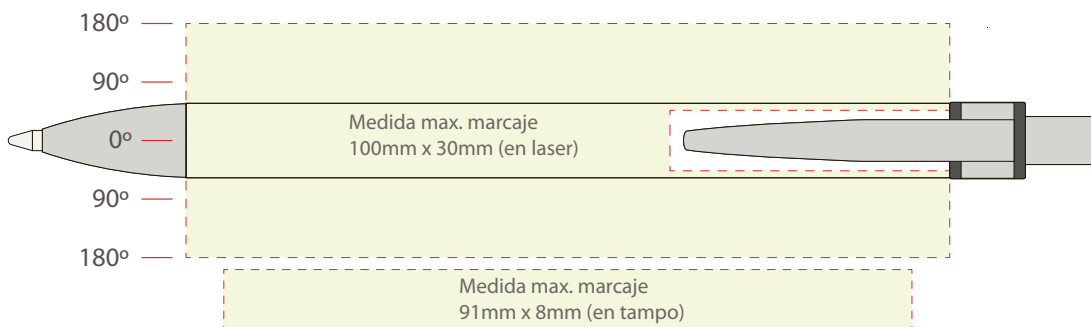

CUERPO



Bolígrafo

Canvas



Mecanismo de pulsación. Cuerpo de aluminio pintado mate.
Terminales plástico pintado mate.

Forma triangular.

Recambio de bolígrafo INOXCROM® con punta de acero inoxidable y bola de carburo de tungsteno de 1mm.

Peso: 21 gr.

Longitud: 143 mm.

Ø: 10,90 mm

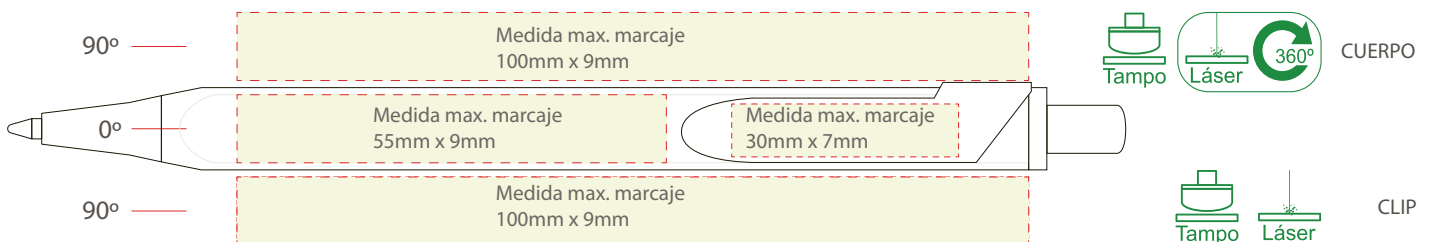



Vera
Soul
Inox70

INOXCROM®
Casual



ALUMINIUM

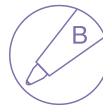

Bolígrafo

Vera

Mecanismo de pulsación. Cuerpo de aluminio pintado mate.
 Terminales metálicos cromados mate.

Recambio de bolígrafo INOXCROM® con punta de acero inoxidable y bola de carburo de tungsteno de 1mm.

Peso: 26 gr.

Longitud: 141 mm.

Ø: 10,35 mm

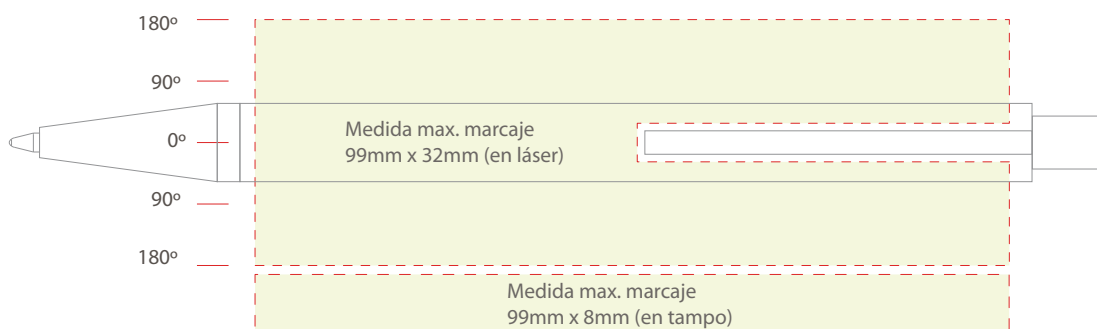

CUERPO

INOXCROM® B2B



ACERO INOXIDABLE / ABS



Bolígrafo

Soul

Mecanismo de pulsación. Capuchón de acero inoxidable. Cuerpo plástico ABS.

Terminales metálicos cromados.

Recambio de bolígrafo INOXCROM® con punta de acero inoxidable y bola de carburo de tungsteno de 1mm.

Peso: 14,50 gr.

Longitud: 136 mm.

Ø: 9,70 mm

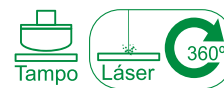
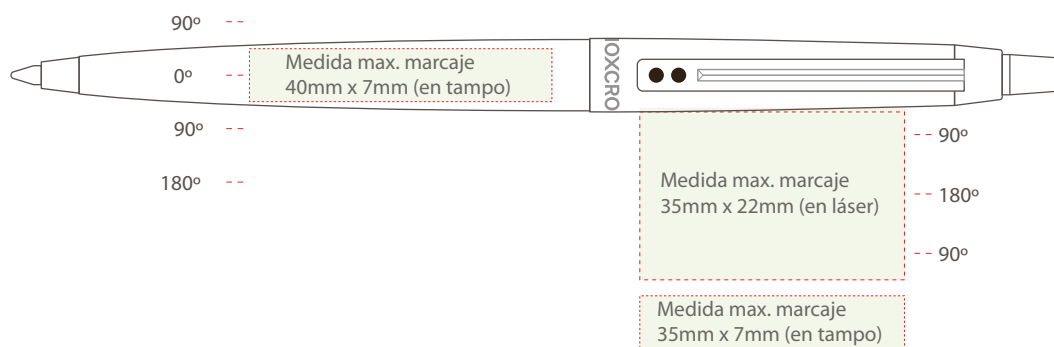

CAPUCHÓN



CUERPO



ACERO INOXIDABLE



Bolígrafo

Inox70

Mecanismo de pulsación. Cuerpo de acero inoxidable
Terminales metálicos cromados.

Recambio de bolígrafo INOXCROM® con punta de acero inoxidable y bola de carburo de tungsteno de 1mm.

Peso: 21,00 gr.

Longitud: 137 mm.

Ø: 9,80 mm

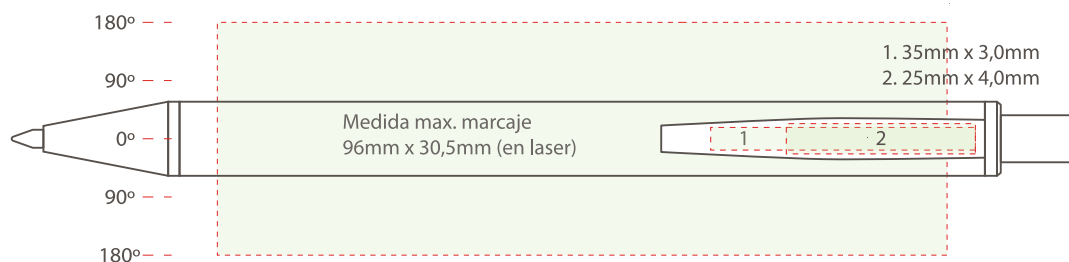

CUERPO



CLIP

Prime
Touch
Beat
Round
Vista
Arc



INOXCROM[®]
Premium

INOXCROM® Prime



Bolígrafo con mecanismo de giro, roller i pluma, con cuerpo metálico lacado y terminales cromados.
Carga de bolígrafo INOXCROM® metálica, tinta soft, con punta de acero inoxidable y bola de carburo de tungsteno de 1mm.
Carga de roller INOXCROM® con punta de acero inoxidable y bola de carburo de tungsteno de 0,7mm.
Plumin de acero inoxidable con punta de iridio de 1mm y cartucho de 38mm de longitud.

Bolígrafo	Roller	Pluma (+ 2 cartuchos)
Peso: 30,5 gr.	Peso: 30 gr.	Peso: 29 gr.
Longitud: 140 mm	Longitud: 142 mm	Longitud: 142 mm
Ø: 12 mm	Ø: 12 mm	Ø: 12 mm



Bolígrafo
Roller
Estilográfica

Prime

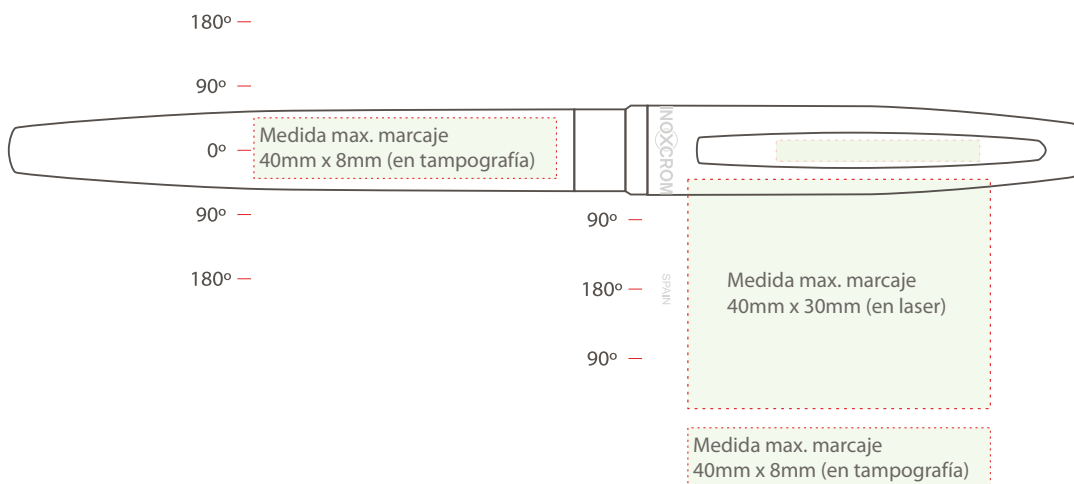

CAPUCHÓN



CUERPO

INOXCROM® Touch



Bolígrafos y portaminas con mecanismo de giro, cuerpo metálico pintado mate/brillo y terminales cromados.
Puntero touch para pantallas táctiles.
Carga de bolígrafo INOXCROM metálica, tinta soft, con punta de acero inoxidable y bola de carburo de tungsteno de 1mm.
Mecanismo de lápiz metálico, con grafito de 0,7 mm y dureza HB.

Bolígrafo	Lapicero mecánico
Peso: 28 gr.	Peso: 31,5 gr.
Longitud: 134 mm	Longitud: 138 mm
Ø: 10 mm	Ø: 10 mm

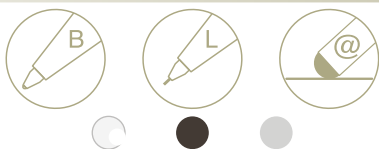

Bolígrafo
Portaminas
Puntero táctil

Touch

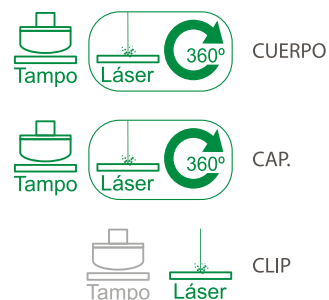
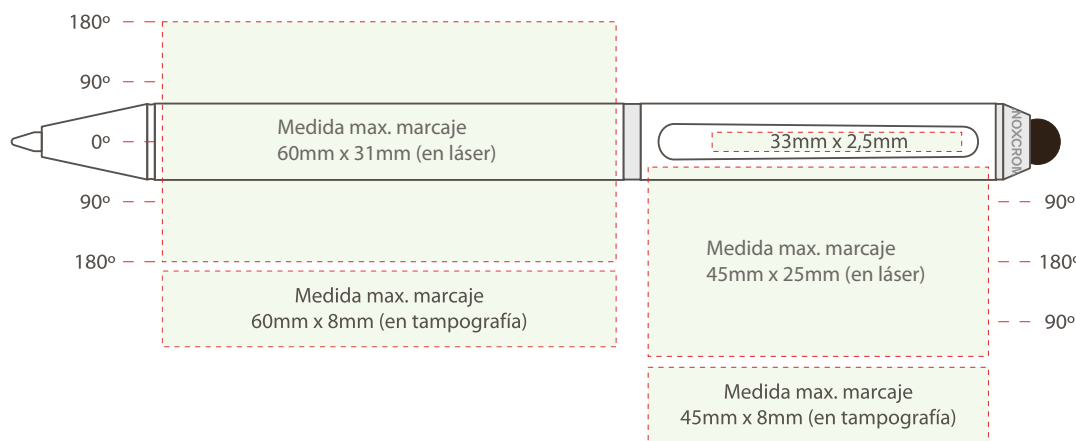

INOXCROM® Beat

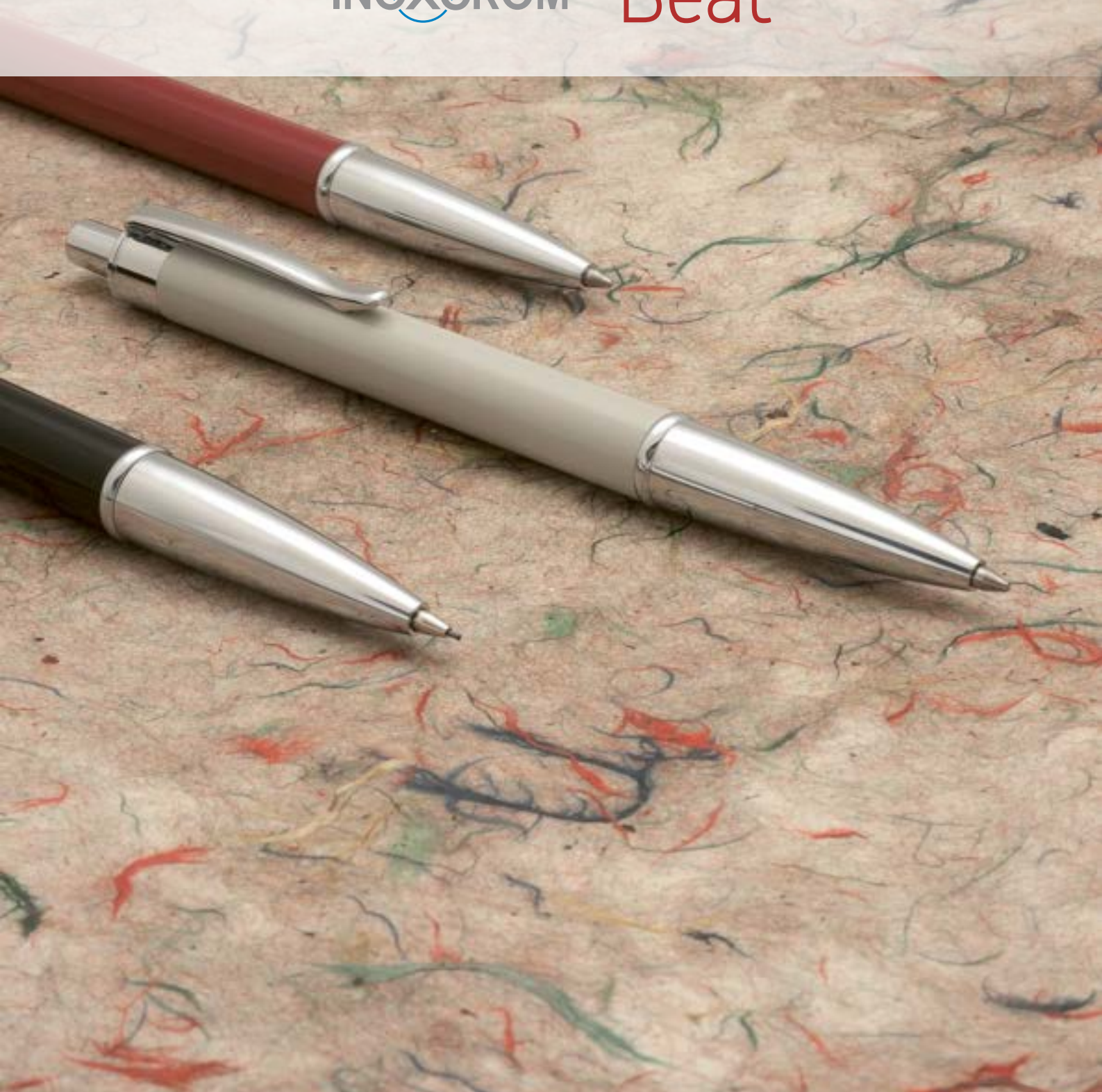

Bolígrafos y portaminas con mecanismo de pulsación, cuerpo metálico lacado y terminales cromados.
Carga de bolígrafo INOXCROM® metálica, tinta soft, con punta de acero inoxidable y bola de carburo de tungsteno de 1mm.
Mecanismo de lápiz metálico, con grafito de 0,7 mm y dureza HB.

Bolígrafo	Portaminas
Peso: 29 gr.	Peso: 30,5 gr.
Longitud: 137,5 mm	Longitud: 143 mm
Ø: 11 mm	Ø: 11 mm

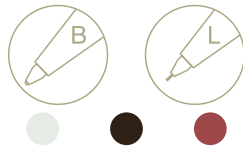

Bolígrafo
Portaminas

Beat

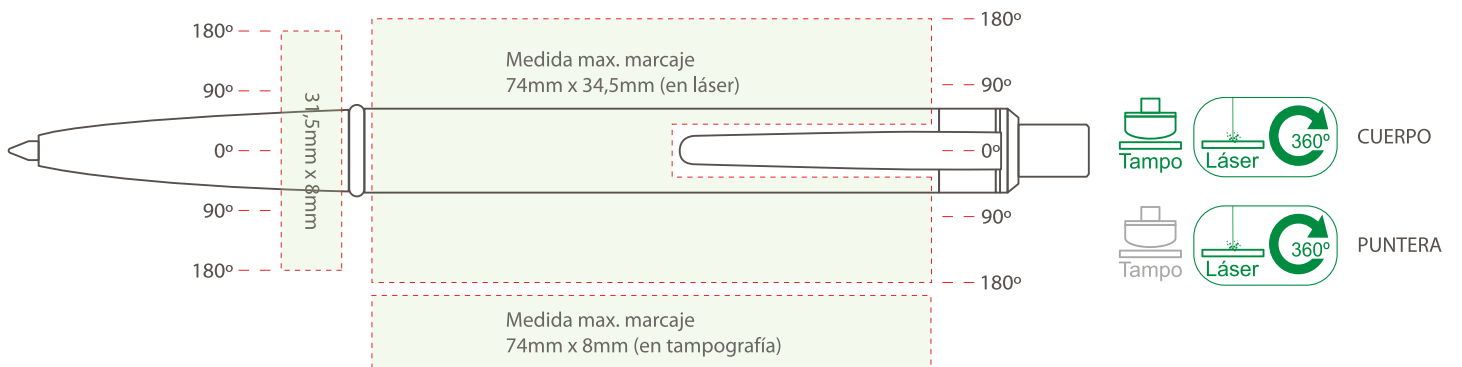

INOXCROM® Round



Bolígrafos y portaminas con mecanismo de pulsación, cuerpo metálico lacado y terminales cromados.
Carga de bolígrafo INOXCROM® metálica, tinta soft, con punta de acero inoxidable y bola de carburo de tungsteno de 1mm.
Mecanismo de lápiz metálico, con grafito de 0,7 mm y dureza HB.

Bolígrafo	Portaminas
Peso: 28,5 gr.	Peso: 27 gr.
Longitud: 138 mm	Longitud: 141,5 mm
Ø: 12 mm	Ø: 12 mm

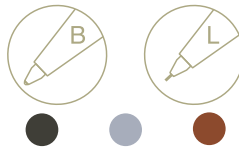

Bolígrafo
Portaminas

Round

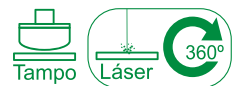
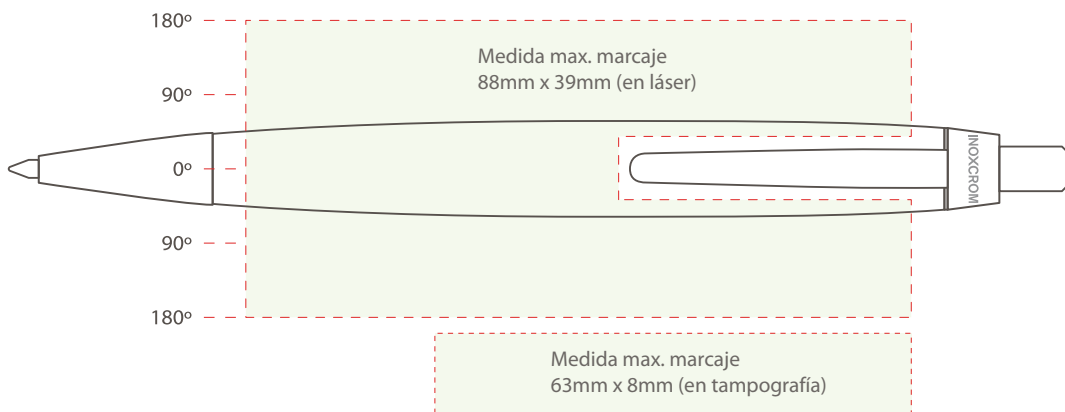

CUERPO

INOXCROM® Vista



Bolígrafo con mecanismo de giro, roller i pluma, con cuerpo metálico lacado y terminales cromados.
Carga de bolígrafo INOXCROM® metálica, tinta soft, con punta de acero inoxidable y bola de carburo de tungsteno de 1mm.
Carga de roller INOXCROM® con punta de acero inoxidable y bola de carburo de tungsteno de 0,7mm.
Plumin de acero inoxidable con punta de iridio de 1mm y cartucho de 38mm de longitud.

Bolígrafo	Roller	Pluma (+ 2 cartuchos)
Peso: 25,5 gr.	Peso: 26 gr.	Peso: 28 gr.
Longitud: 131 mm	Longitud: 131 mm	Longitud: 131 mm
Ø: 10,5 mm	Ø: 10,5 mm	Ø: 10,5 mm

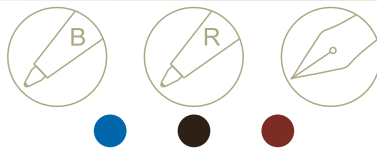

Bolígrafo
Roller
Estilográfica

Vista

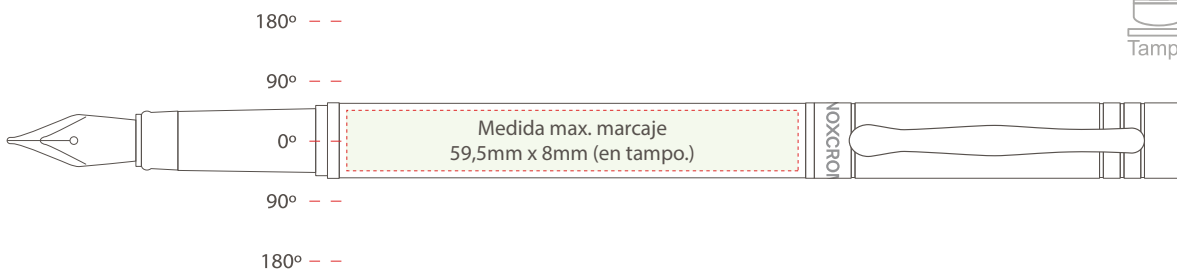
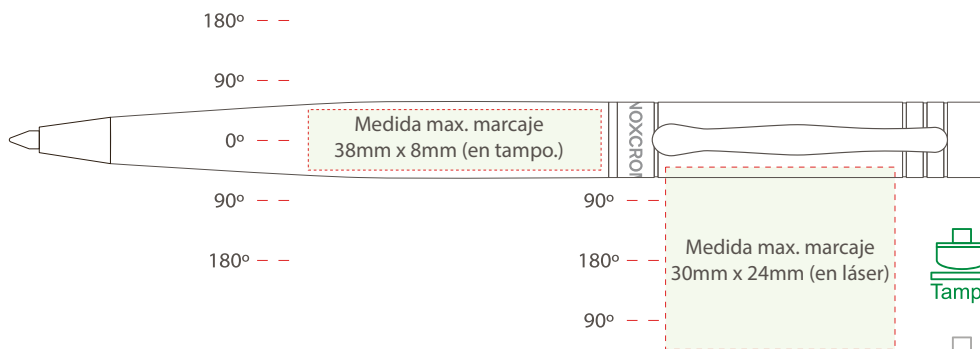

INOXCROM® Arc



Bolígrafo con mecanismo de giro y pluma, con cuerpo metálico lacado y terminales cromados.
Carga de bolígrafo INOXCROM® metálica, tinta soft, con punta de acero inoxidable y bola de carburo de tungsteno de 1mm.
Plumin de acero inoxidable con punta de iridio de 1mm y cartucho de 38mm de longitud.

Bolígrafo	Pluma (+ 2 cartuchos)
Peso: 35 gr.	Peso: 32 gr.
Longitud: 138,5 mm	Longitud: 137,6 mm
Ø: 12,6 mm	Ø: 12,6 mm

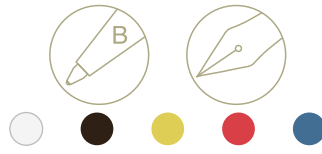

Bolígrafo Estilográfica

Arc



E-Premium

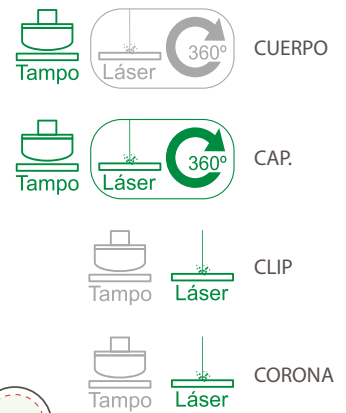
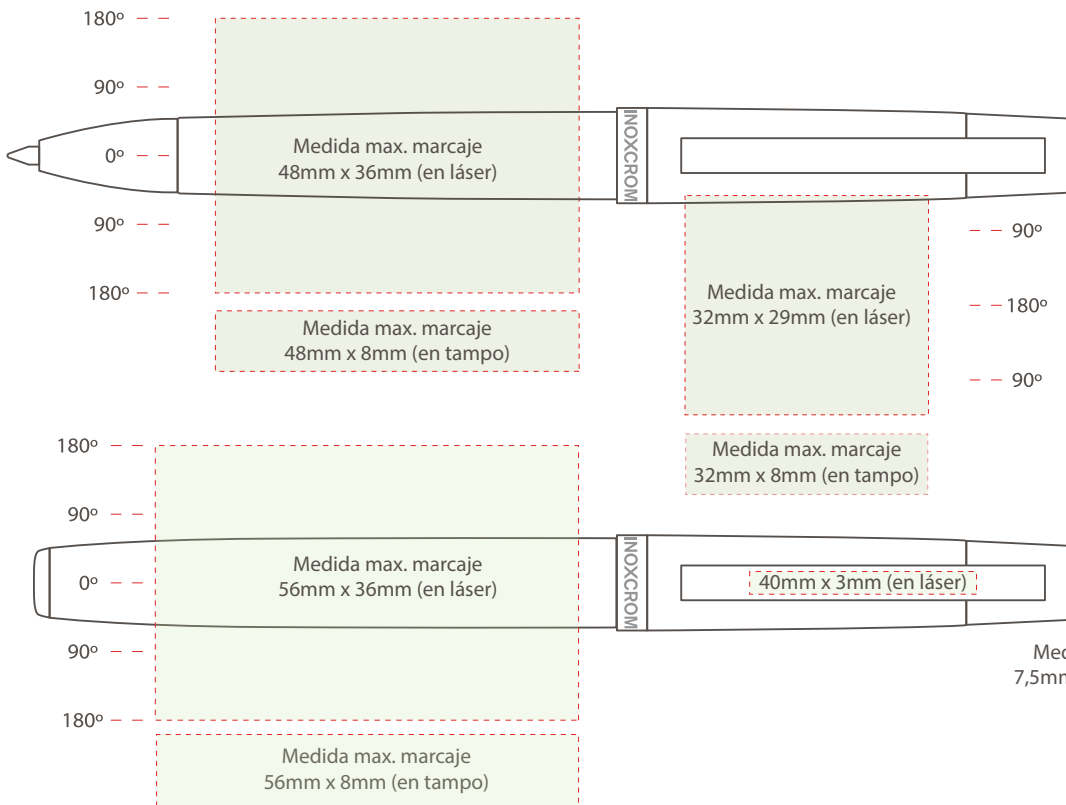

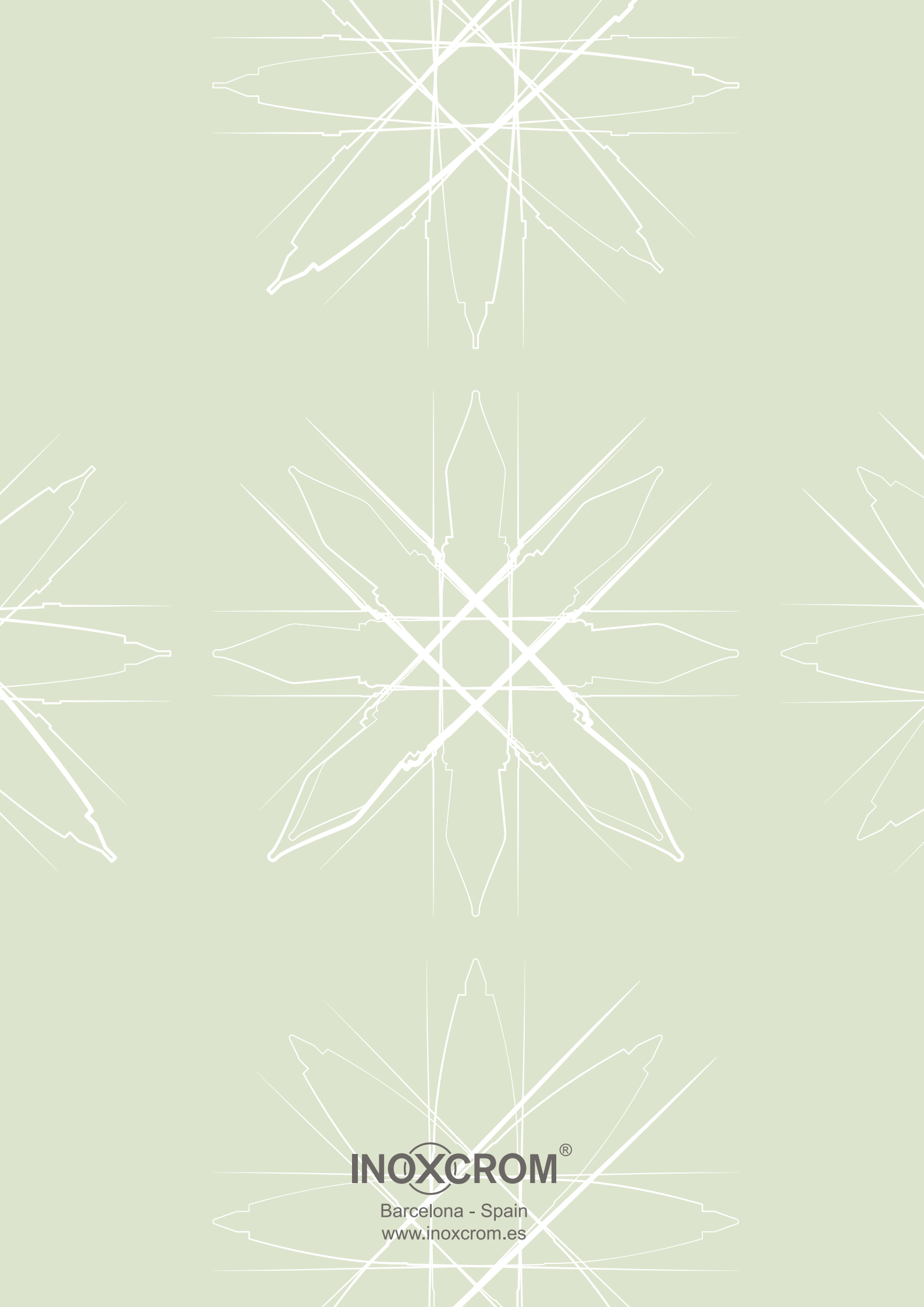

INOXCROM[®]

Barcelona - Spain
www.inoxcrom.es